

According to our policy of continuous improvement, dimensions, features or components of this product can be partially or completely changed without prior notice. It's Customer responsibility to verify that this is the last version of the drawing

Property of IBERSPA S.L. Avda. Pla d'Urgell 2-8 25200 Cervera, Spain. Don't use without permission. Keep this information confidential and use it solely for the permitted purpose.

CONTROL COMPONENTS

ZONE 1: SWIM

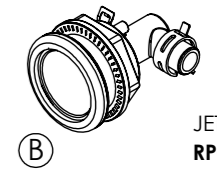
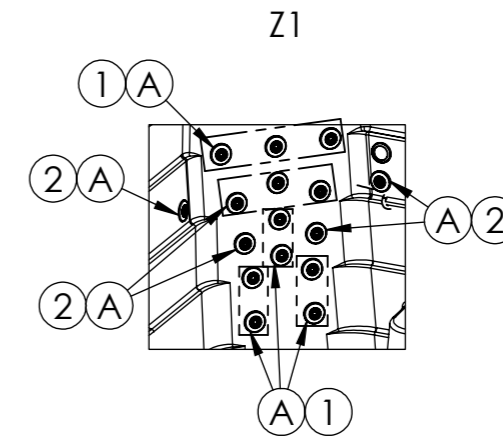
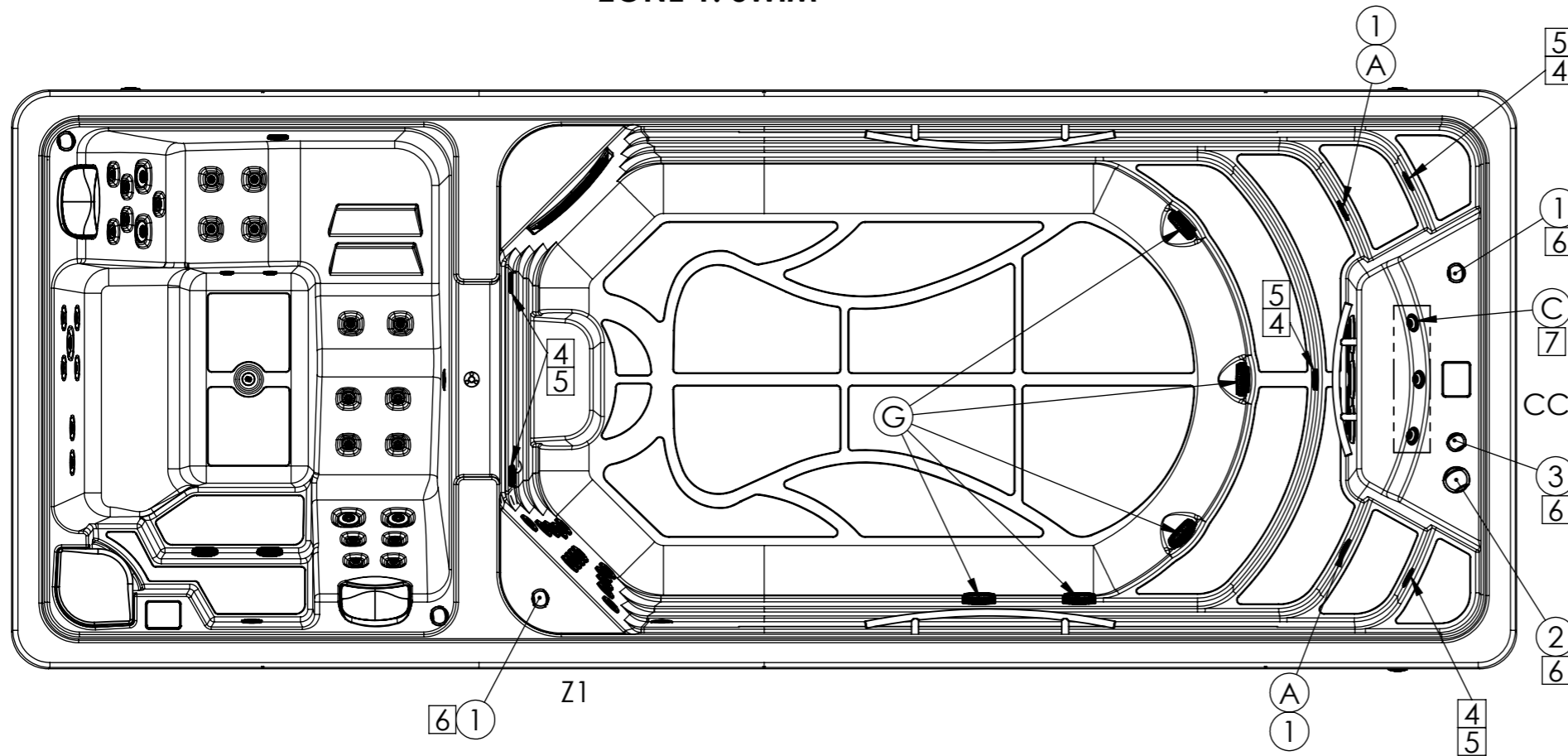

JET BODY SET 3"
RPOR0376



FRONTAL JET 3"
SS DIRECTIONAL
RPOR0376-A



FRONTAL JET 3"
SS TWIN ROTO
RPOR0376-B



FOUNTAIN SS
RPOR0301



SWIM JET
STAINLESS STEEL
RPOR0282

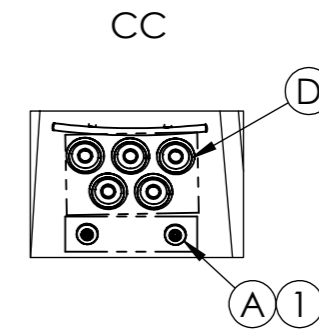

VENTURY
CONTROLLER SS
RPOR0261

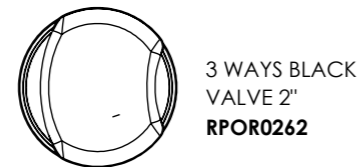

3 WAYS BLACK
VALVE 2"
RPOR0262



3 WAYS BLACK
VALVE 1"
RPOR0286

LIGHT COMPONENTS



SPOTLIGHT
LED SET RD
RPOR0239

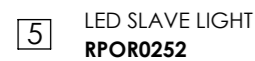

LED SLAVE LIGHT
RPOR0252

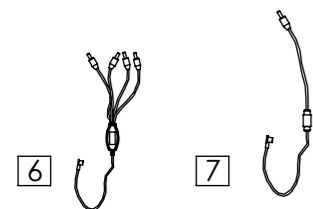

4 LEDS LIGHTS
POINTS
RPOR0267

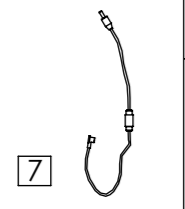

1 LEDS LIGHTS
POINTS
RPOR0268



LEDS TRANSFORMER
5V DC
RPOR0280



LEDS
CONTROLLER
RPOR0281

CONTROL PANELS



CONTROL PANEL
SPA TOUCH 3
RPOR0409

HEATER

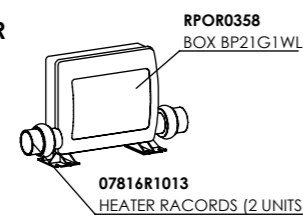

07816R1013
HEATER RACORDS (2 UNITS)

- RPOR0101 - TEMPERATURE PROBES GS I GL (x2)
- RPOR0105 - HEATER 3KW GS I GL
- RPOR0358-A - DIGITAL PANEL BP21G1WL
- RPOR0330 - EXPANDER BOARD KIT FOR SYSTEM BP21G1WL
- RPOR0358-B - LEVEL SENSOR

PUMPS

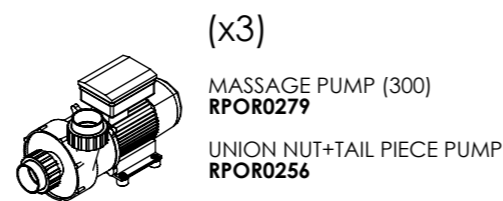

(x3)

MASSAGE PUMP (300)
RPOR0279

UNION NUT+TAIL PIECE PUMP
RPOR0256



FILTRATION PUMP
200W IBE136
RPOR0404

FILTRATION

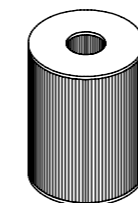

FILTER CARTRIDGE
50 SQ FT
RPOR0405-A

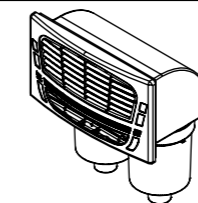

DUAL SKIMMER GRAPHITE
100 SQ FT
RPOR0405

DOOR GRAPHITE SKIMMER
DOUBLE 100 SQ FT
RPOR0405-B
SKIMMER GASKET EPDM70
420X250
RPOR0405-B

DESINFECTATION

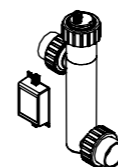

UV DESINFECTATION
SYSTEM 21W
RPOR0397

AUDIO

NOU AUDIO BBA3

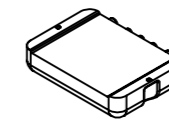

RECEPTOR AUDIO
BLUETOOTH BBA3
RPOR0416

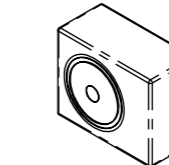

EXTENSION CABLE
RPOR0370

SUBWOOFER
RPOR0208



SPEAKER
RPOR0295

OTHER COMPONENTS



SPECIAL HANDGRIP
SPA 1000
RPOR0198



SPECIAL HANDGRIP
SPA 600
RPOR0250



FASTENING SWIMM SET
RPOR0342



SUPER HI-FLO
SUCTION 2" GREY
RPOR0166

COVER 74456

According to our policy of continuous improvement, dimensions, features or components of this product can be partially or completely changed without prior notice. It's Customer responsibility to verify that this is the last version of the drawing

Property of IBERSPA S.L. Avda. Pla d'Urgell 2-8 25200 Cervera, Spain. Don't use without permission. Keep this information confidential and use it solely for the permitted purpose.

CONTROL COMPONENTS

ZONE 2: BATH

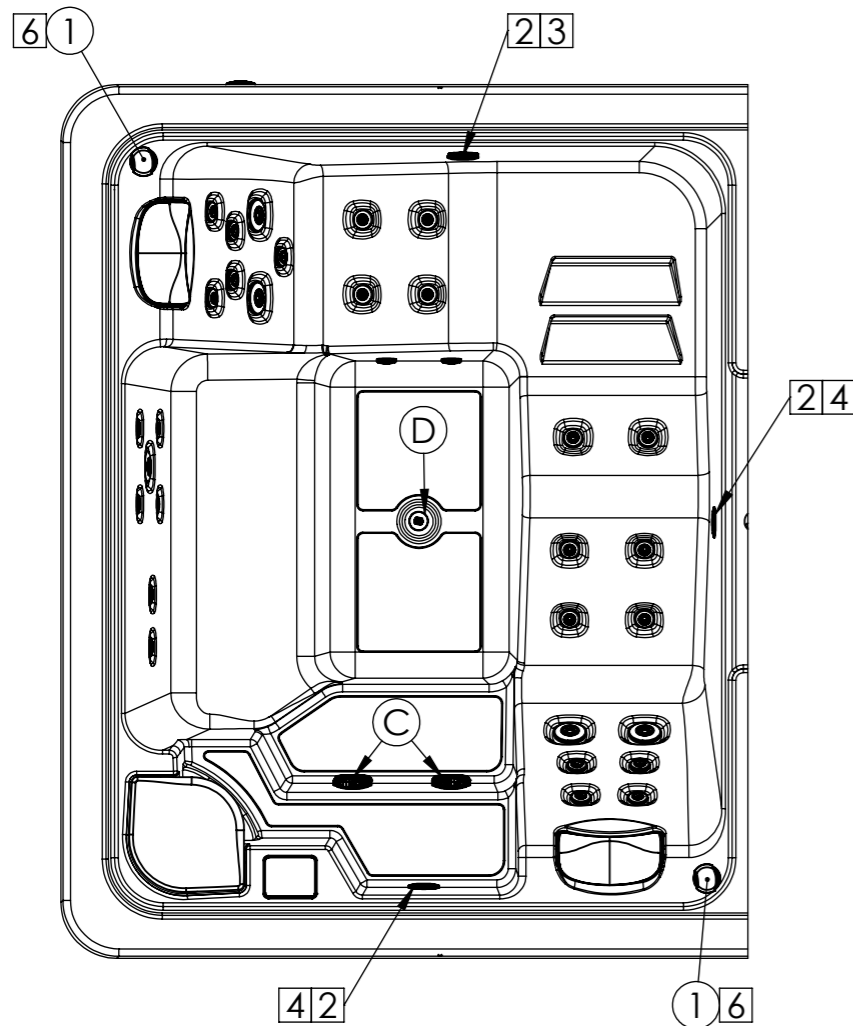

MASSAGE COMPONENTS

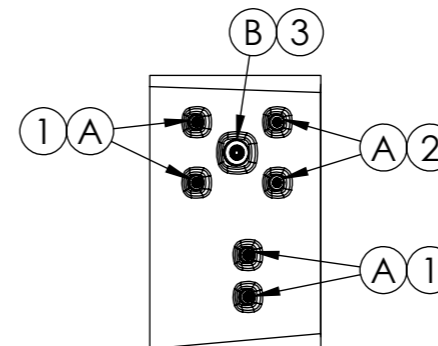
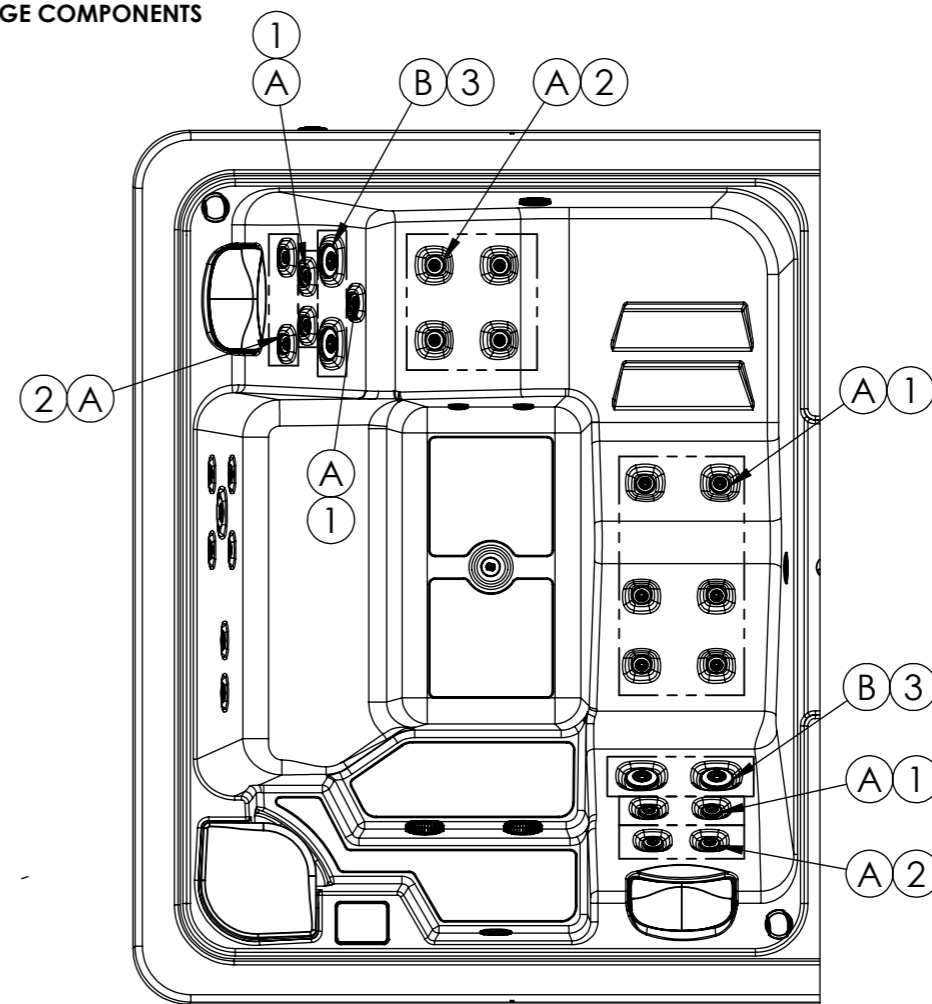

LIGHT COMPONENTS

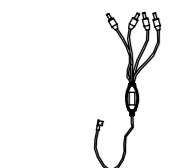
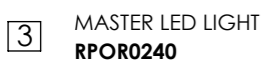

CONTROL PANELS



HEATER

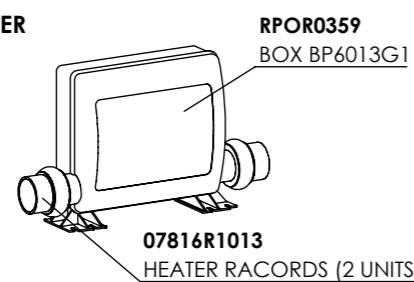

RPOR0101 - TEMPERATURE PROBES GS I GL (x2)
RPOR0105 - HEATER 3KW GS I GL
RPOR0359-A - DIGITAL PANEL BP6013G1

PUMPS

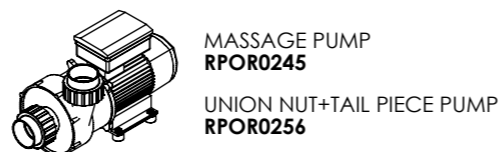

FILTRATION

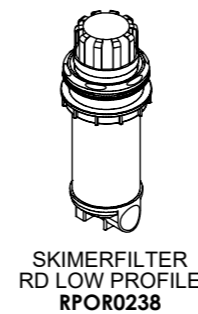

DESINFECTATION



AUDIO

NOU AUDIO BBA3



EXTENSION CABLE RPOR0370



OTHER COMPONENTS



COVER 74456